

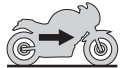

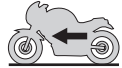
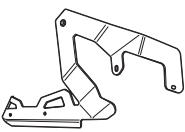
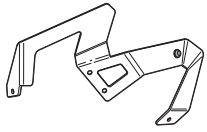

## XT1200Z WORLD CROSSER SKID PLATE

23P-F84R0-V0-00

Posnr.	QTY		
①	1		
②	2	 Ø6	
③	2	 Ø6x13	
④	8		 M6x16
⑤	6		 M6

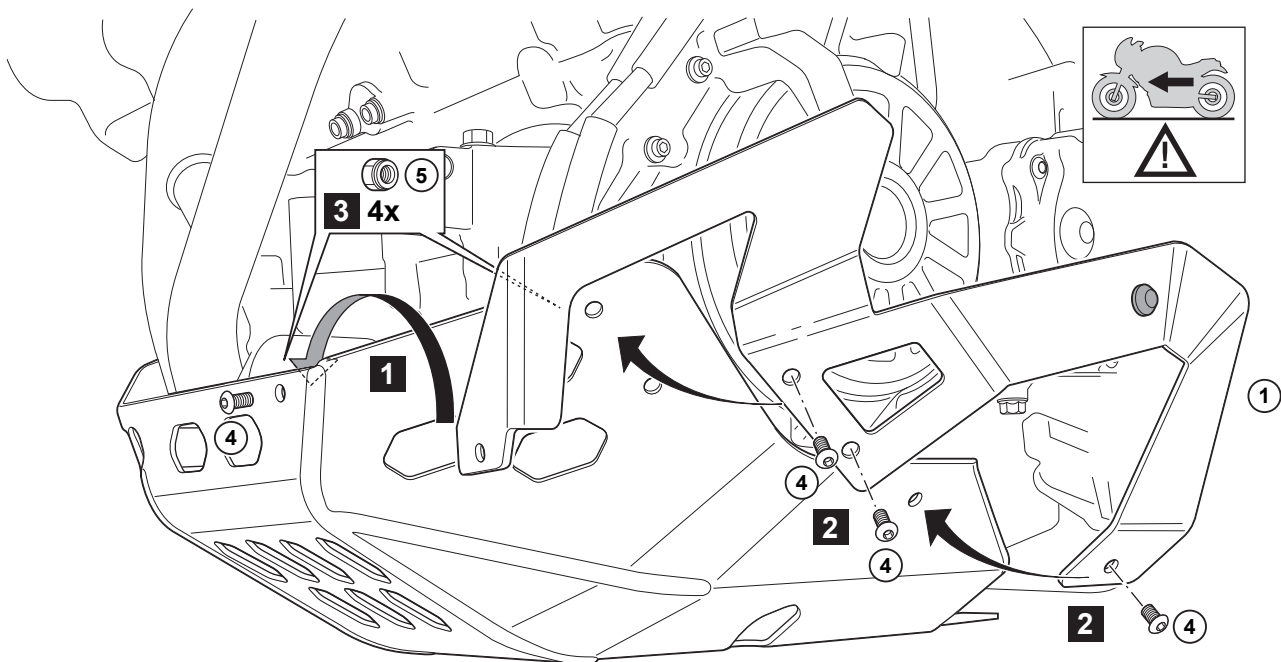

## XT1200Z WORLD CROSSER SKID PLATE

